

LITA

design David Dolcini

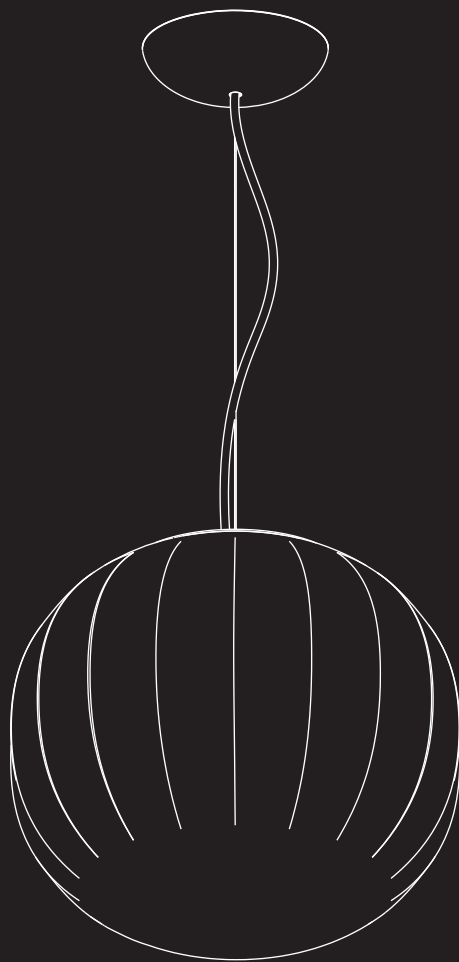

**LUCE
PLAN**

D92



D92S14

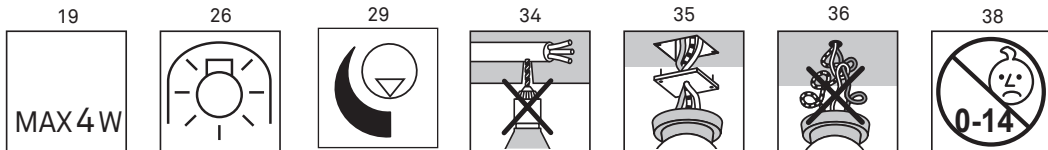
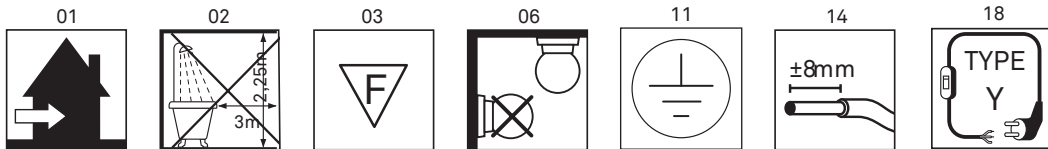

D92S18

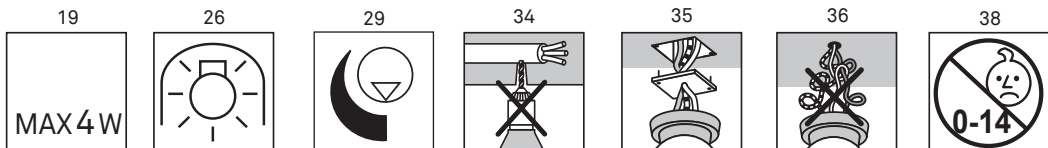
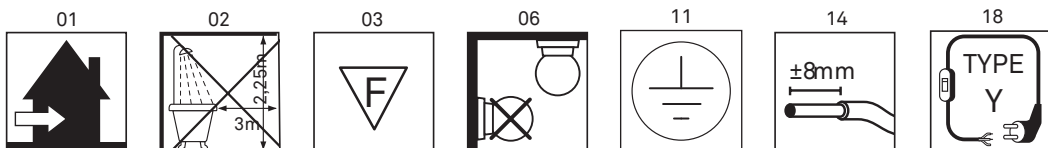

D92S30

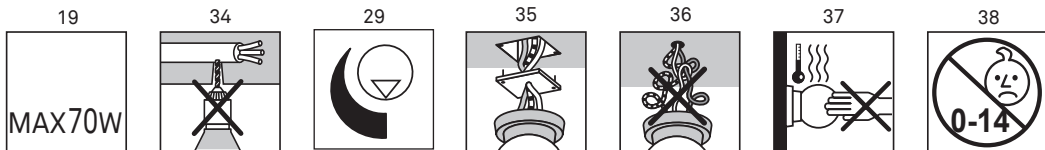
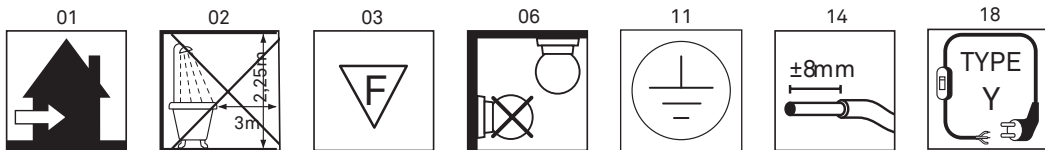

D92S42

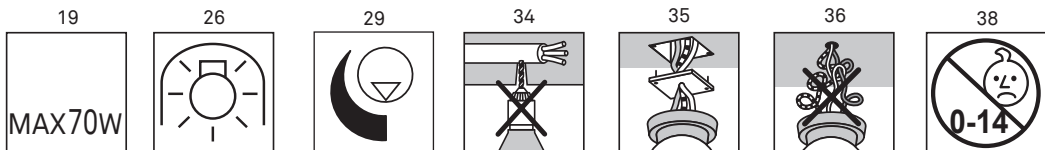
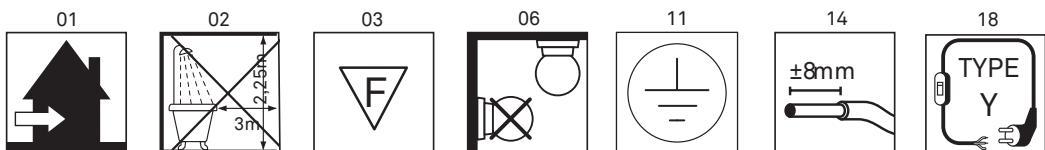

D92S14

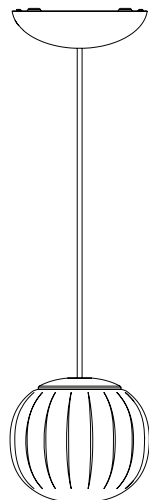

14 cm
5.51"

max 314 cm - min. 114 cm

max 123.62" - min. 44.88"



a



b

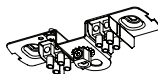

x1

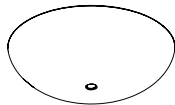

x1



x1

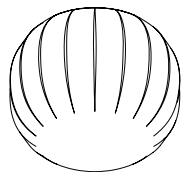

x1

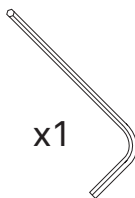

x1

kg 1.1kg

lb 2.42lb

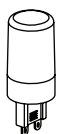

MAX
4W
LED
G9

D92S18 + D92/2



a



b

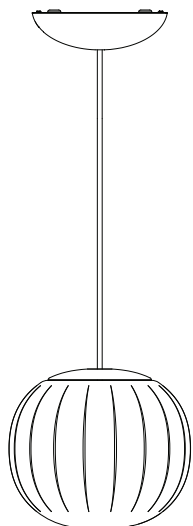

18 cm
7.08"

max 318 cm - min. 118 cm

max 125.19" - min. 46.45"



x1

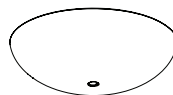

x1

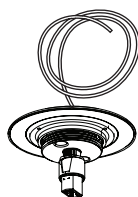

x1



x1

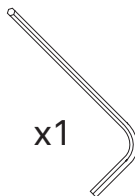

x1

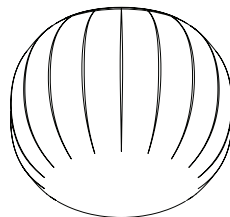

x1

kg 1.3kg

lb 2.86 lb

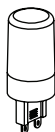

MAX
4W
LED
G9

D92S30 + D92/3

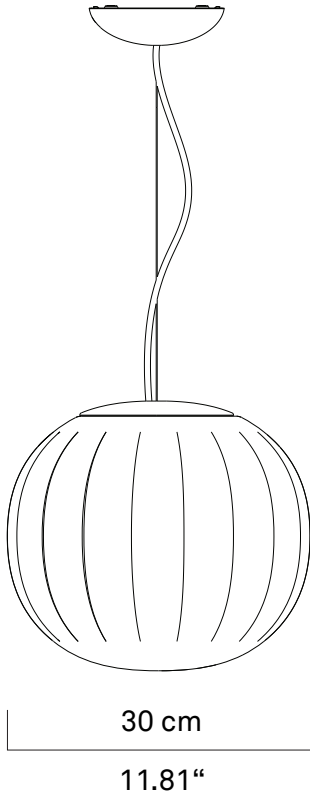

max 330 cm - min. 130 cm

max 129.92" - min. 51.18"

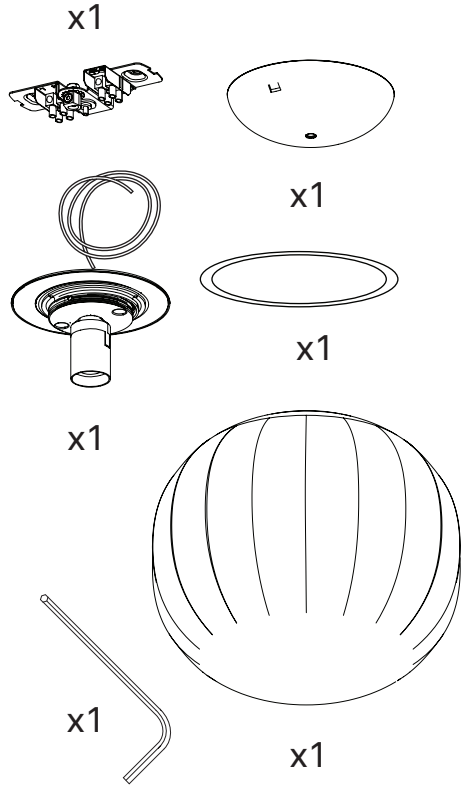
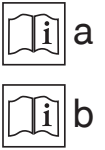

kg 2.3kg

lb 5 lb



D92S42 + D92/4

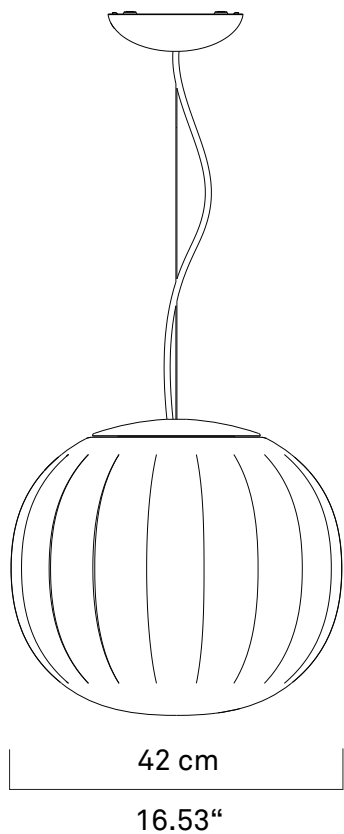

max 342 cm - min. 142 cm

max 134.64" - min. 55.90"

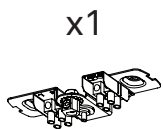

x1

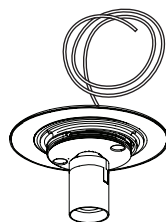

x1

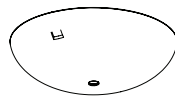

x1



x1

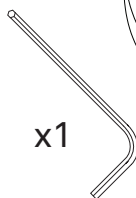

x1

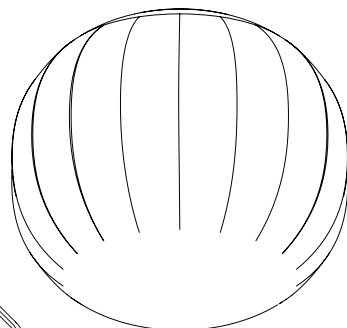

x1



a



b

kg 5.3kg

lb 11.7 lb



MAX
16W
LED
E27



MAX
70W
E27

1 | 1.1 D92S14 - D92S18

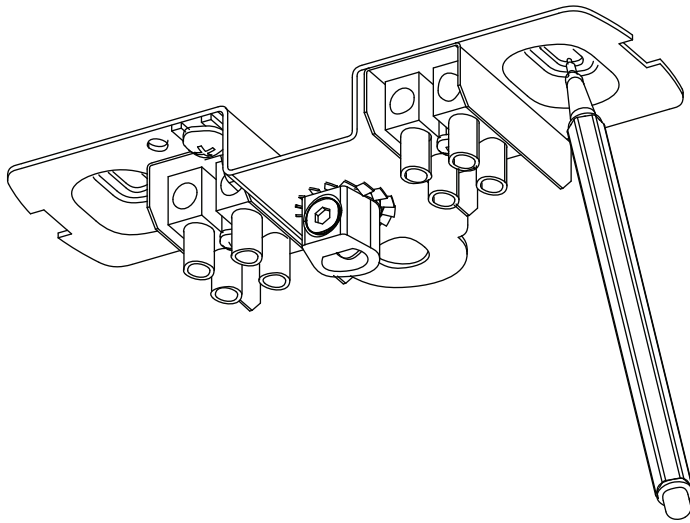

D92S30 - D92S42

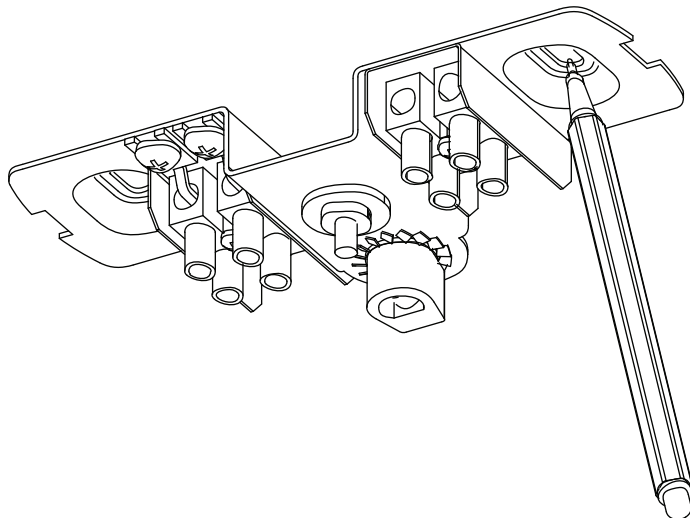

1.2

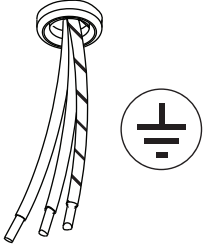
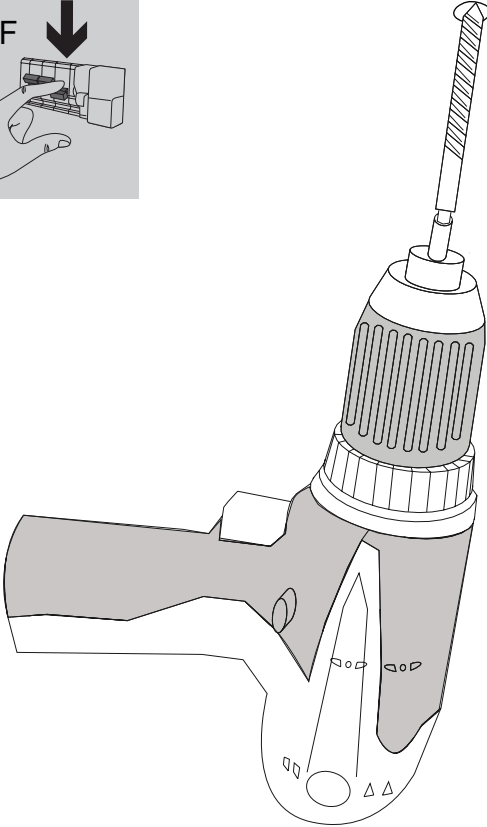
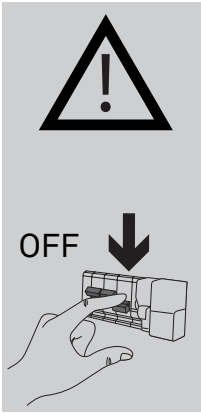

1.3 D92S14 - D92S18

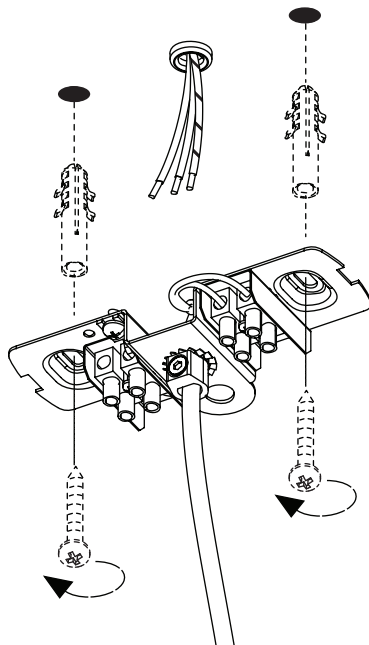

D92S30 - D92S42

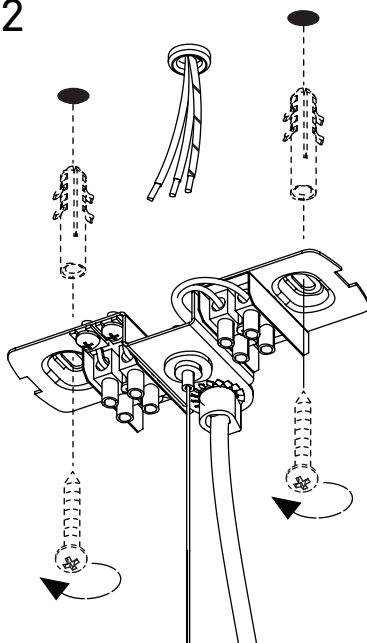

1.4 D92S14 - D92S18

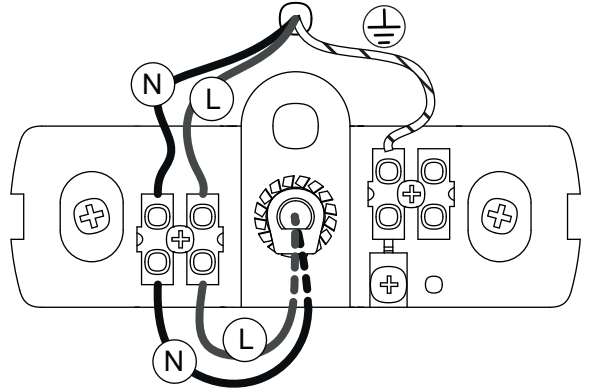
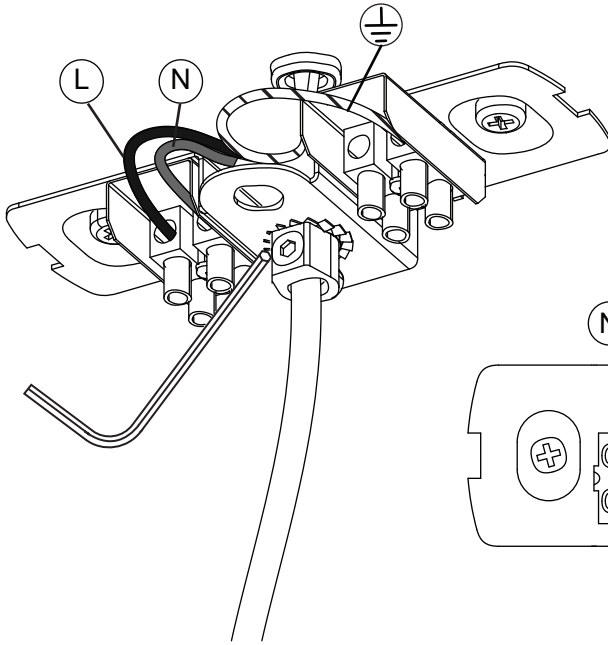

D92S30 - D92S42

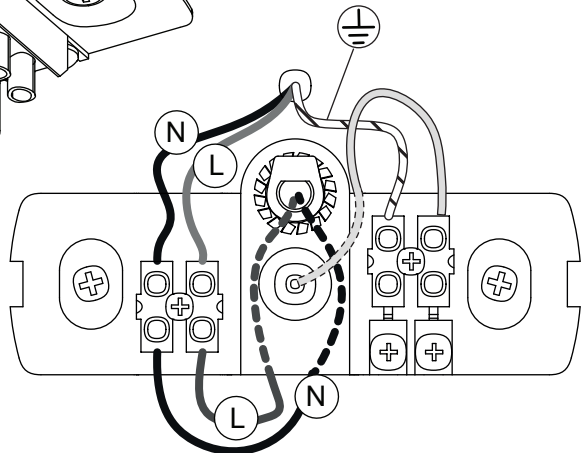
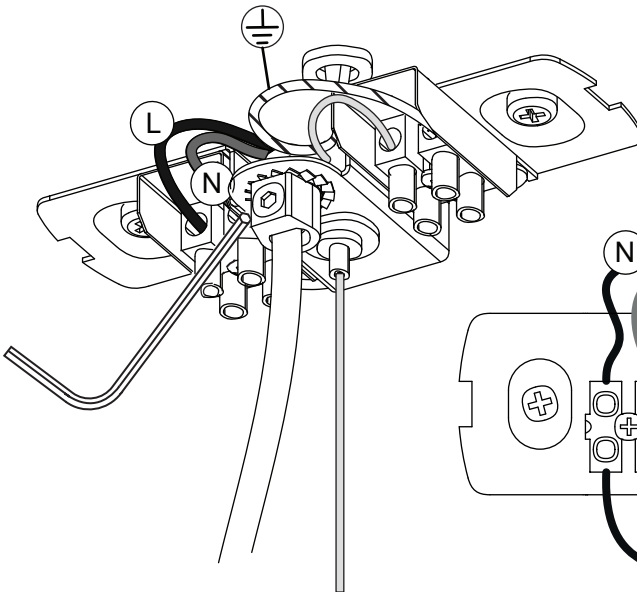

1.5 D92S14 - D92S18

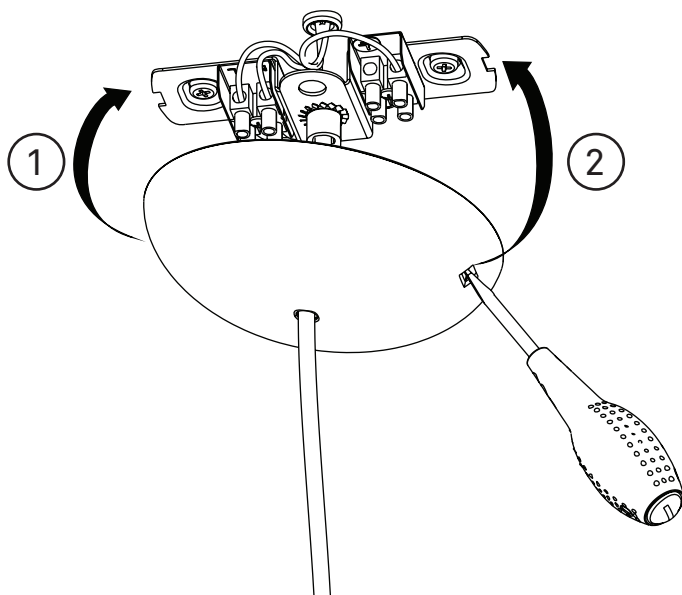

D92S30 - D92S42

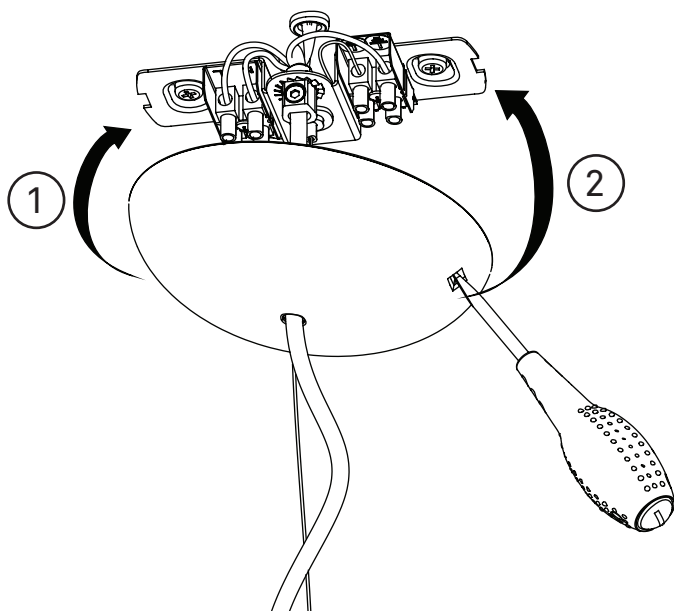

2

D92S14

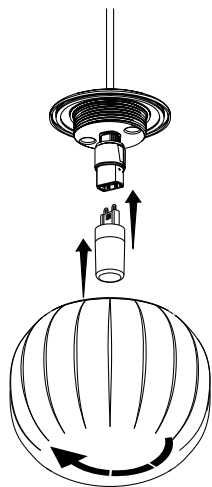

D92S18

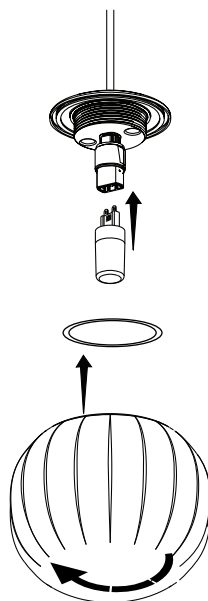

D92S30 - D92S42

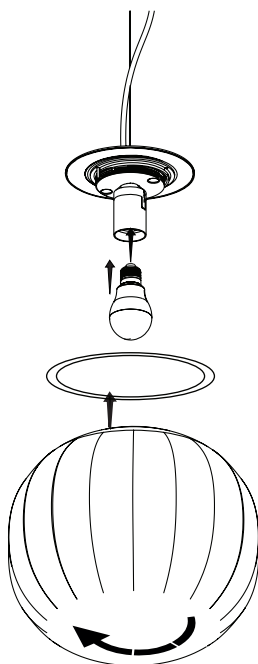

3

3.1 D92S30 - D92S42

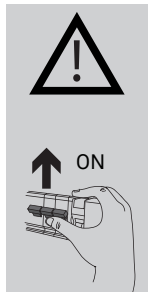
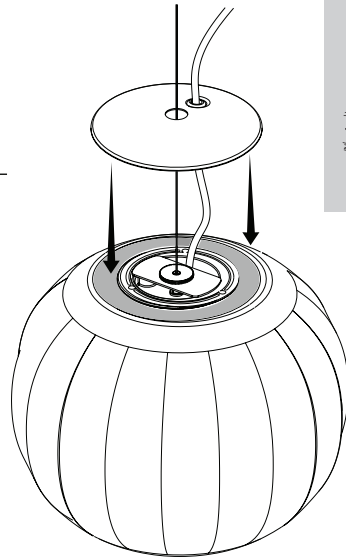
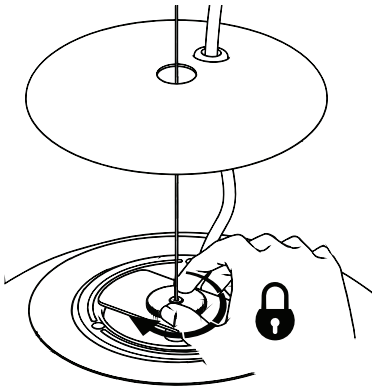
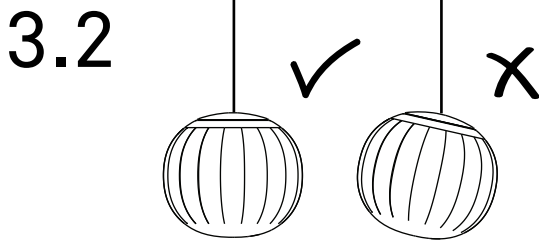
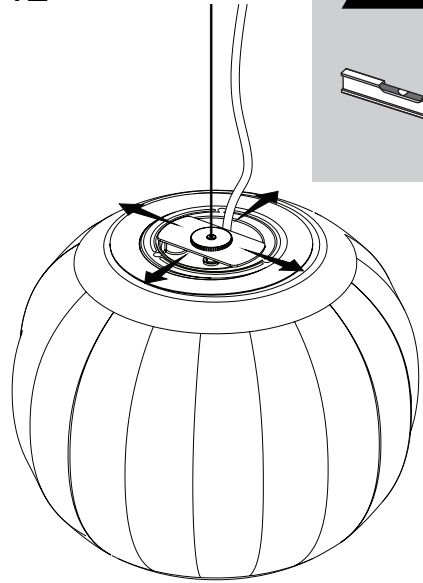
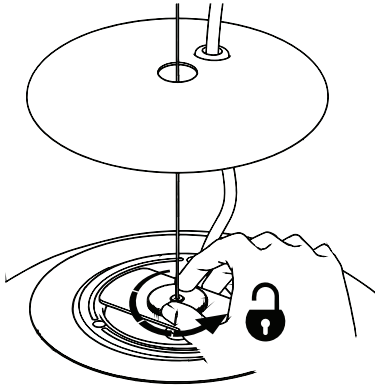

4

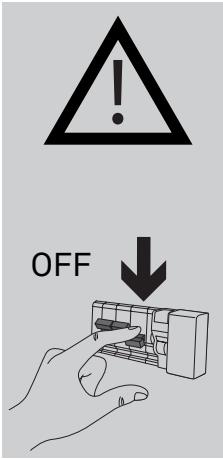

1.

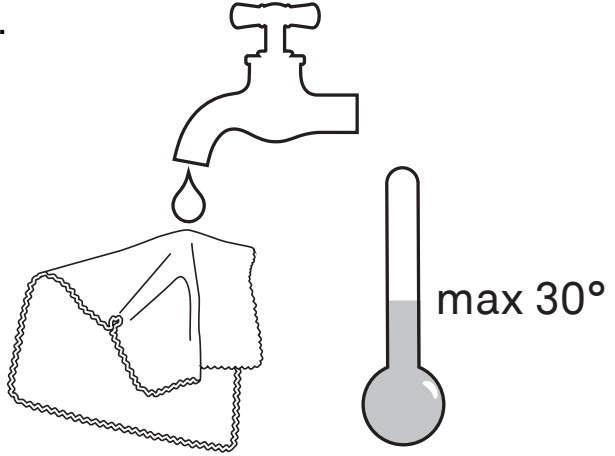

2.



3.

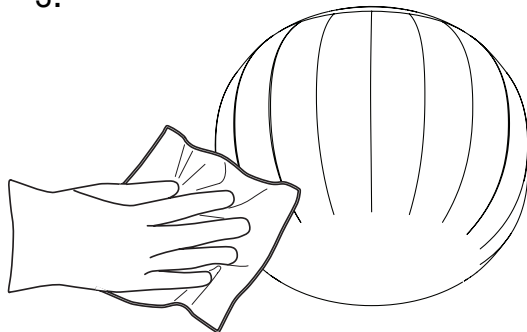



www.luceplan.com

D9201C003